

Worksheet: 2D Figures Resulting from Slicing a Given 3D Shape

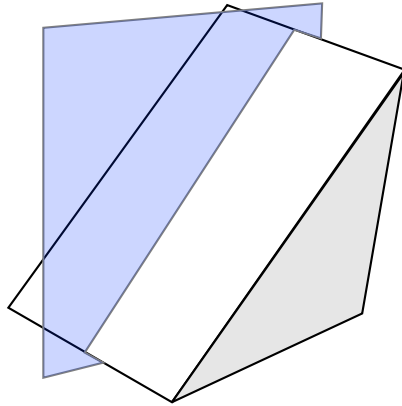

Q1: Determine the two-dimensional figure that results from slicing the given three-dimensional shape as shown.



A

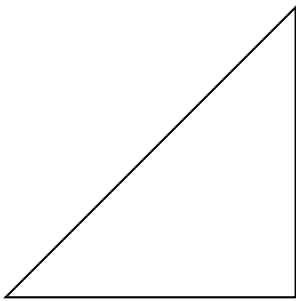

B

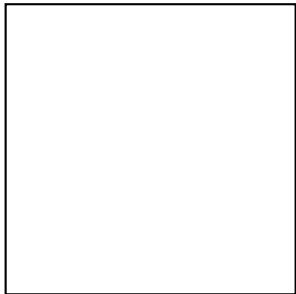

C

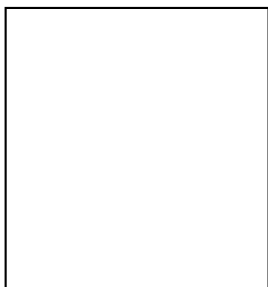
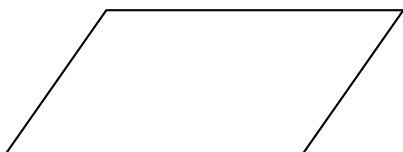

Q2: Determine the two-dimensional figure that results from slicing the given three-dimensional shape as shown.

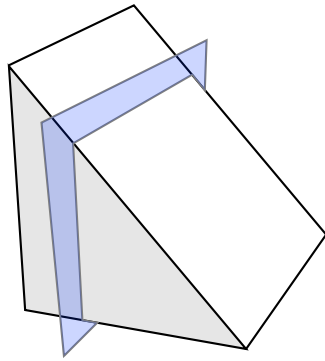

A

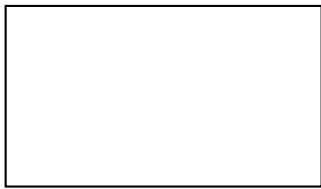

B

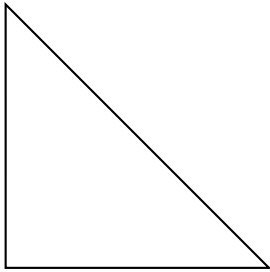

C



D

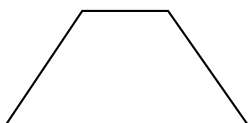
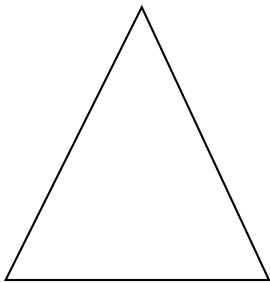

Q3: Determine the two-dimensional figure that results from slicing the given three-dimensional shape as shown.

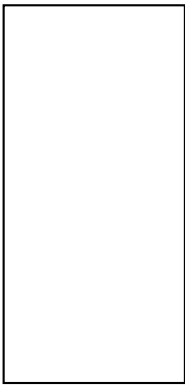
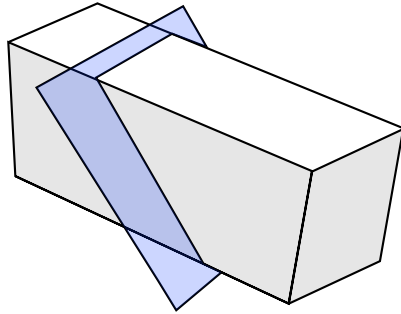

A

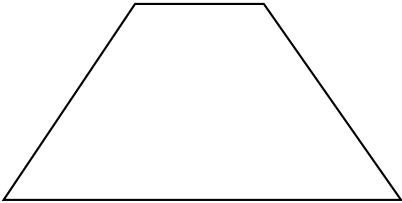

B

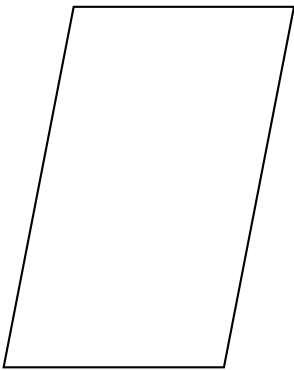

C

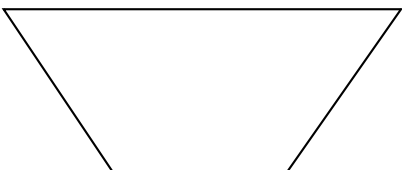

4

Q4: Determine the two-dimensional figure that results from slicing the given three-dimensional shape as shown.

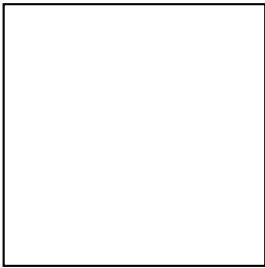
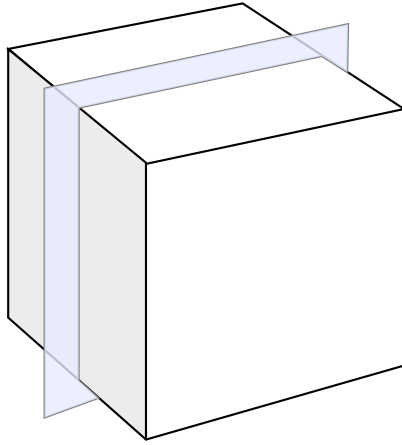

A

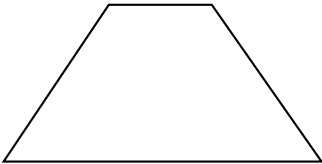

B

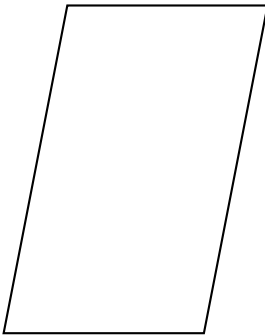

C

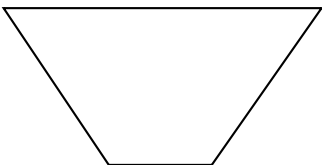

5

D

Q5: Determine the two-dimensional figure that results from slicing the given three-dimensional shape as shown.

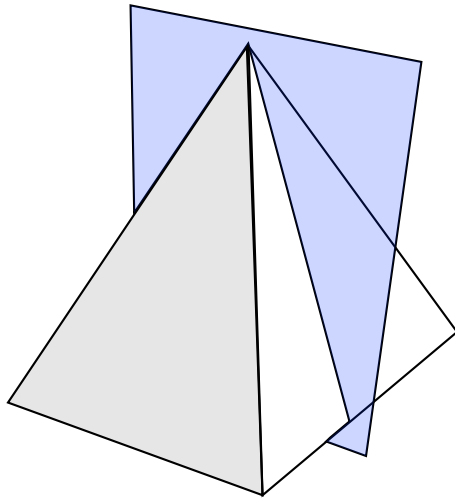

A

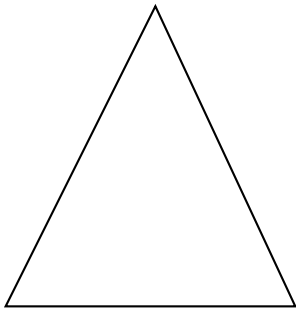

B

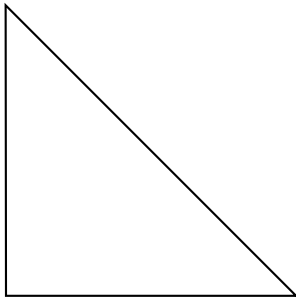

C

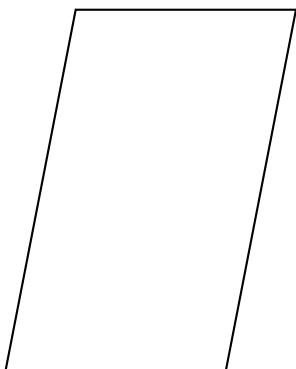

Q6: Determine the two-dimensional figure that results from slicing the given three-dimensional shape as shown.

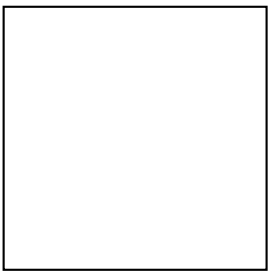
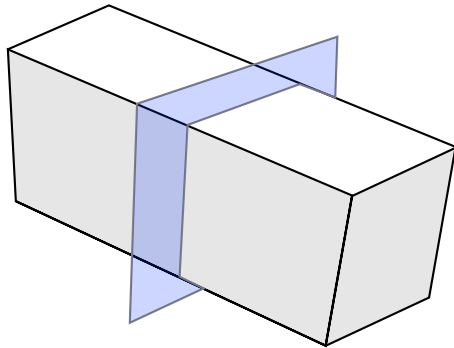

A

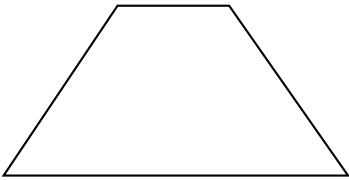

B

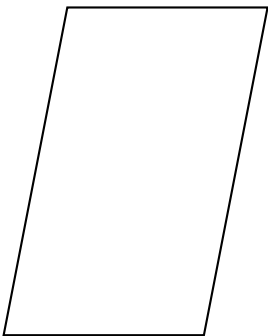

C

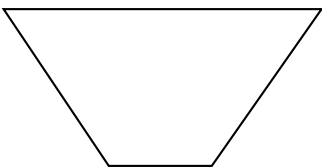

D

Q7: Determine the two-dimensional figure that results from slicing the given three-dimensional shape as shown.

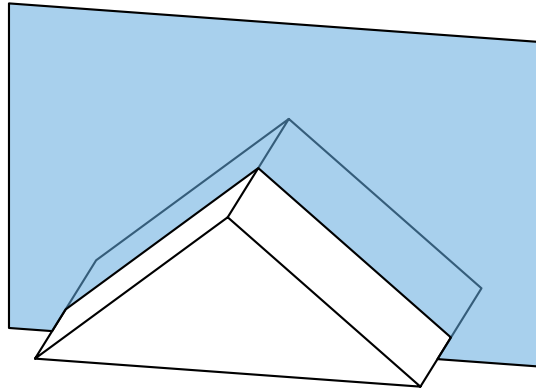

A

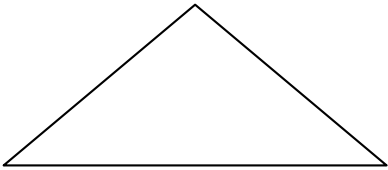

B

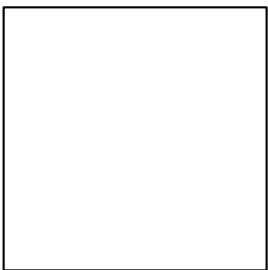

C

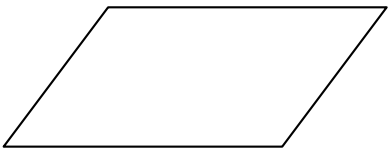

D

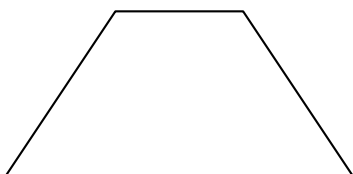
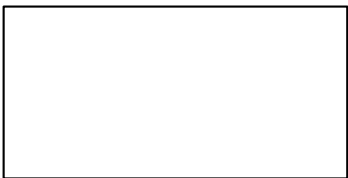

Q8: Determine the two-dimensional figure that results from slicing the given three-dimensional shape as shown.

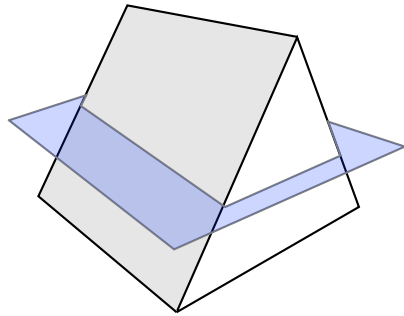

A

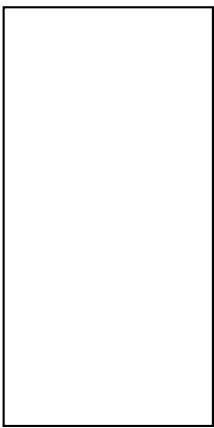

B

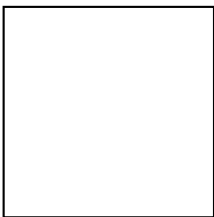

C

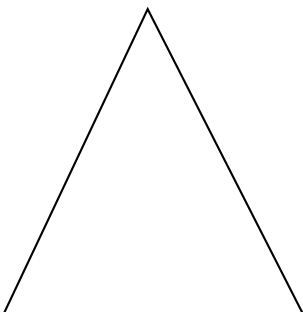

Q9: Determine the two-dimensional figure that results from slicing the given three-dimensional shape as shown.

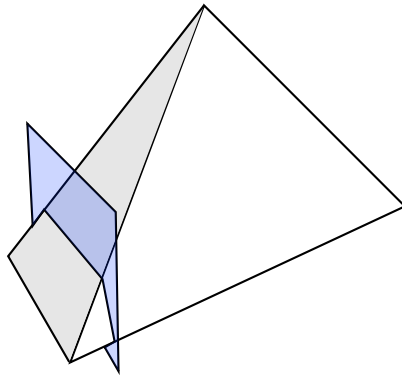

A

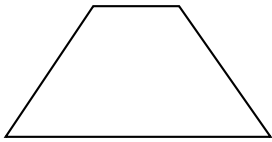

B

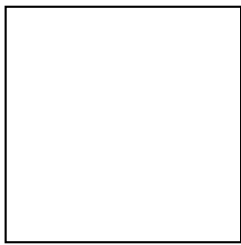

C



D

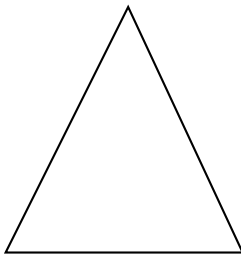

10
E

